

FLYINGWINGS AEROSPORT

V-TRAINER VALUE KIT



The V-Trainer was designed for the new learner in mind, its also great for more experienced pilots who want a stable flying model for aerial photography.

The V-Trainer is made from super tough EPP foam, it can be assembled using either CA Glue, Hot Glue or UHU POR glue.

Contents List:

EPP Foam Set
Ply wing attachment plates
Emax CF2805 Motor with propeller and adaptor
18 amp Brushless Speed Controller (ESC)
Pushrods
Hardware pack

Equipment required

2 x Micro servo (9g)
1 x Small receiver
1700-2200mah 2 cell Lipo
Transmitter with v-tail or
elevon mixing
Lipo Charger

PLEASE NOTE THAT THE MOTOR SUPPLIED IS NOT SUITABLE FOR 3 CELL OPERATION

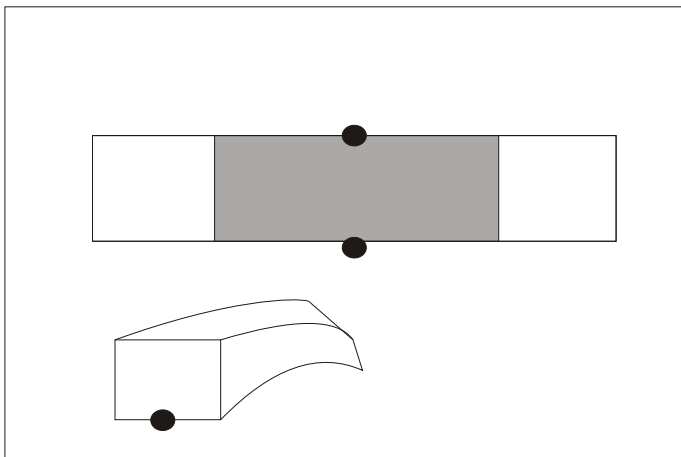

Step1: Measure the centre point of the wing back and front and mark with a felt tip pen. Mark the centre point of the wing top.

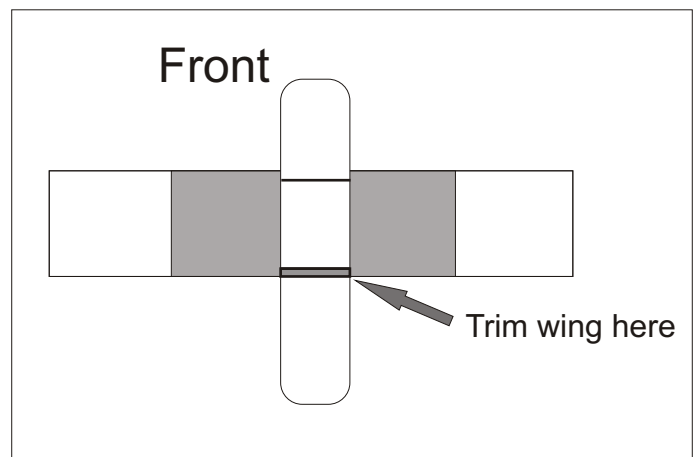

Step 2: Dry assemble (no glue) the wing onto the fuselage and then the wing top. You will notice that the wing is slightly wider than the top (approx 3mm), trim this to the width of the fuselage.

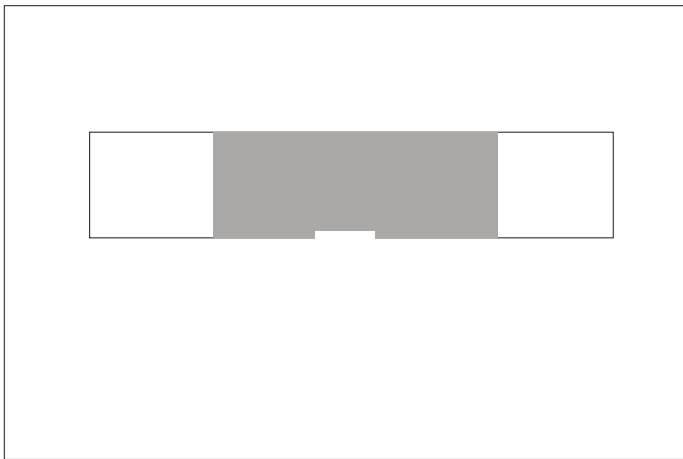

Step 3: The wing should look like this. Using the centre marks done in step 1, glue the wing top to the wing. Do this with the wing on the fuselage to get the correct fit, **but be careful not to glue the wing or top to the fuselage.**

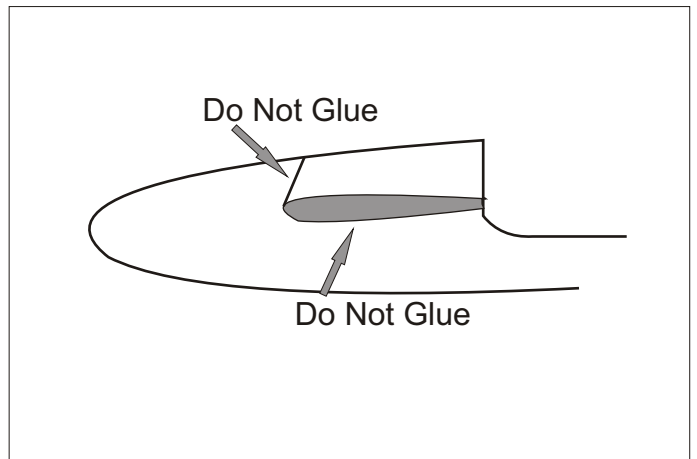

Step 4: Make sure that the wing, top and fuselage fit snugly.

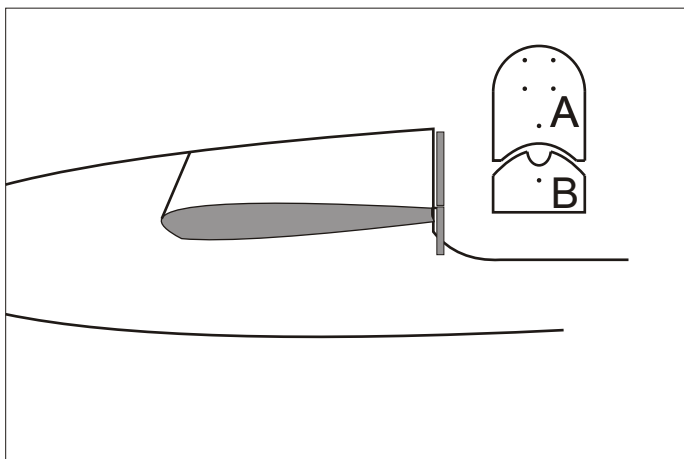

Step 5: Remove the ply plate from the set. The plate with 6 dots on it, as shown.

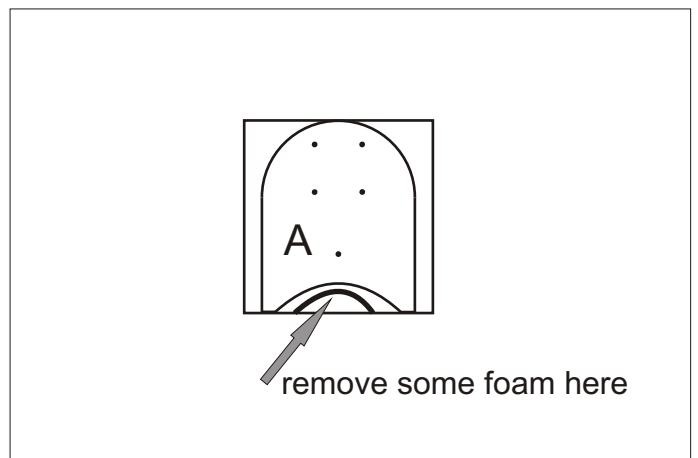

Step 6: Glue the motor plate, to the back of the wing top as shown. remove some foam where shown, this is for the motor cables.

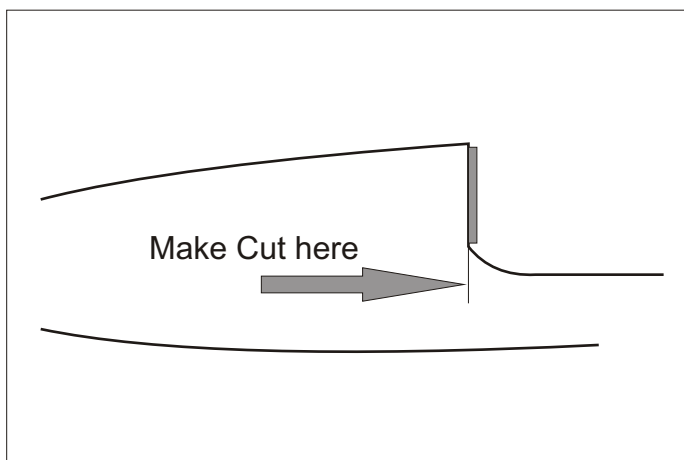

Step 7: Make a cut approx 15mm where shown. Cut in line with the plate part A, so that the two parts align vertically.

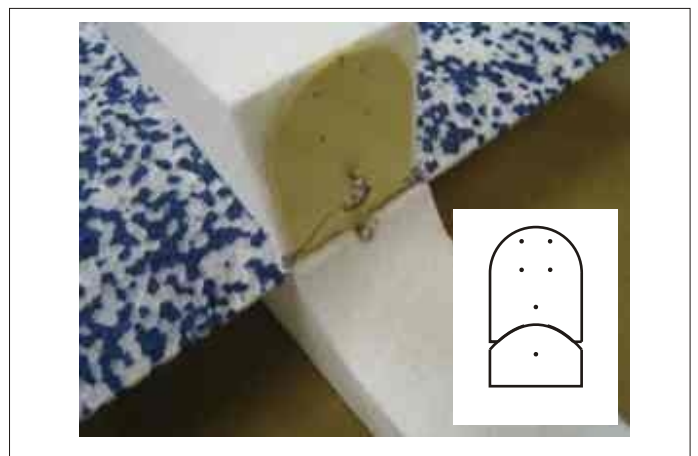

Step 8: The two plates should line up, then glue in part B into the cut slot. Attach self tapping screws leaving 3mm proud.

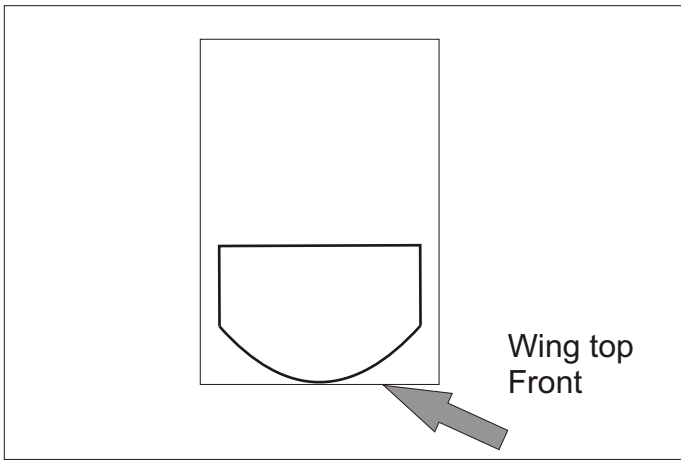

Step 9: Glue the front wing plate to the wing top, as shown.



Step 10: Glue on the other plate, lined up with the front plate as shown, attach self tapping screws leaving 3mm proud.



Step 11: Put the wing aside. Now cut out the radio bay on the fuselage beneath where the wing sits. This is marked out. Follow the marked lines, the depth to cut should be around 20mm, this may vary according to the size of your receiver.



Step 12: Cut around the line drawn on the fuselage, make criss cross cuts in side the pattern. Use a small screwdriver to pick out the foam, bit by bit until the receiver and ESC fit well.

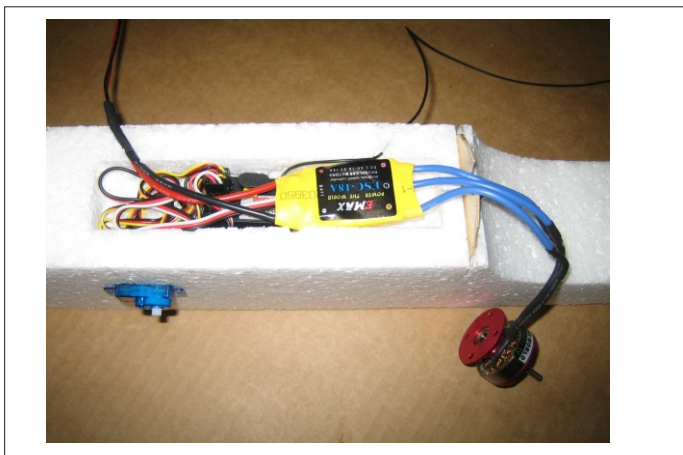

Step 13: The picture shows a typical radio installation.

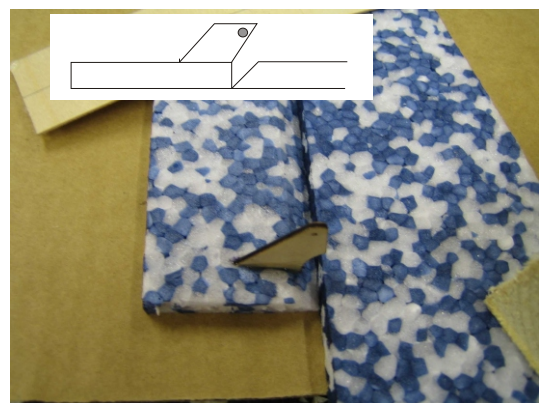

Step 14: Cut a small slot and glue in horns as shown on both elevators on the side of the v channel in the hinge.



Step 15: V-Tail Assembly. Use a set square or a CD case to join the v-tail together at 90 degrees.



Step 16: Glue in the tail assembly into the V cut in the rear of the fuselage, with the elevators facing rearwards.



Step 17: Measure the depth of your servos from the bottom to the servo lugs as shown.



Step 18: Cut out servo holes as marked in the side of the fuselage. Check fit of servo and make changes as required.



Step 19: Use a small screwdriver to pierce a hole from inside the servo hole to the radio compartment made earlier



Step 20: Feed the servo plug through to the radio compartment. Seat the servo in the hole and glue the lugs with CA glue.

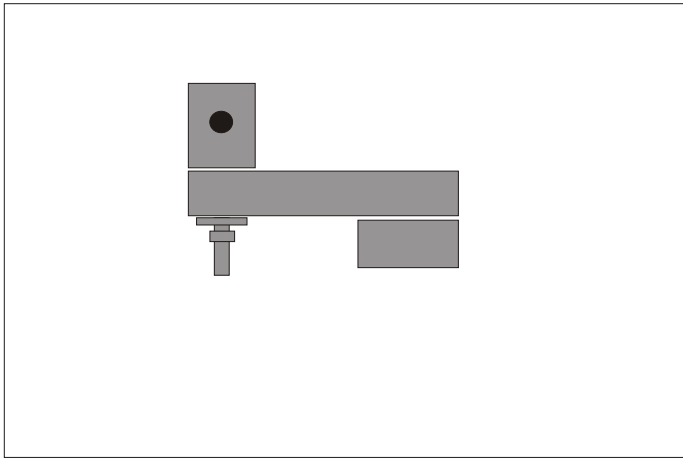

Step 21: Attach the pushrod adaptor to the servo arm, note it should be able to rotate in the arm.



Step 22: Thread the Z-bend on the end of the metal pushrod through the horn on the elevator, and the other end through the servo adaptor. The servo should be at 90 degrees to the servo as shown.

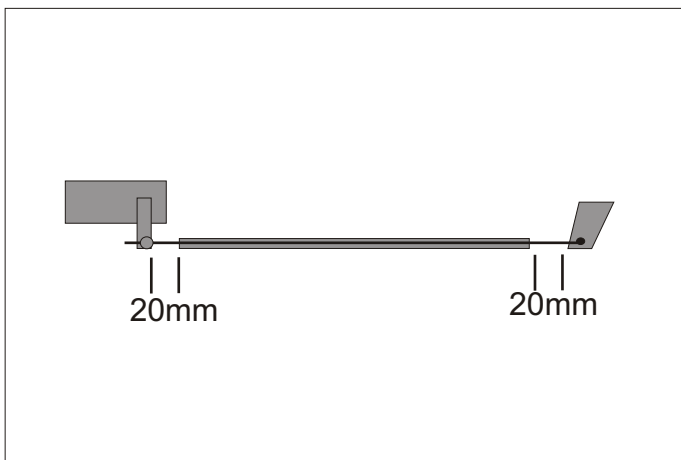

Step 23: Remove the metal pushrod from the servo end and feed the plastic tube down. Cut the tube so that there's a gap in the tube 20mm at both ends.



Step 24: Trim the surplus wire at the servo end but leave 20mm for adjustment. Use the un-required wire to make U-shapes to secure the tube to the fuselage, gluing with CA glue.



Step 25: There is two options for battery installation, this one shows the Lipo pack Attached using Velcro to the top of the nose.



Step 26: This one shows a recess cut into the nose to accommodate the battery (recommended).

Radio Setup

SERVO MOVEMENT

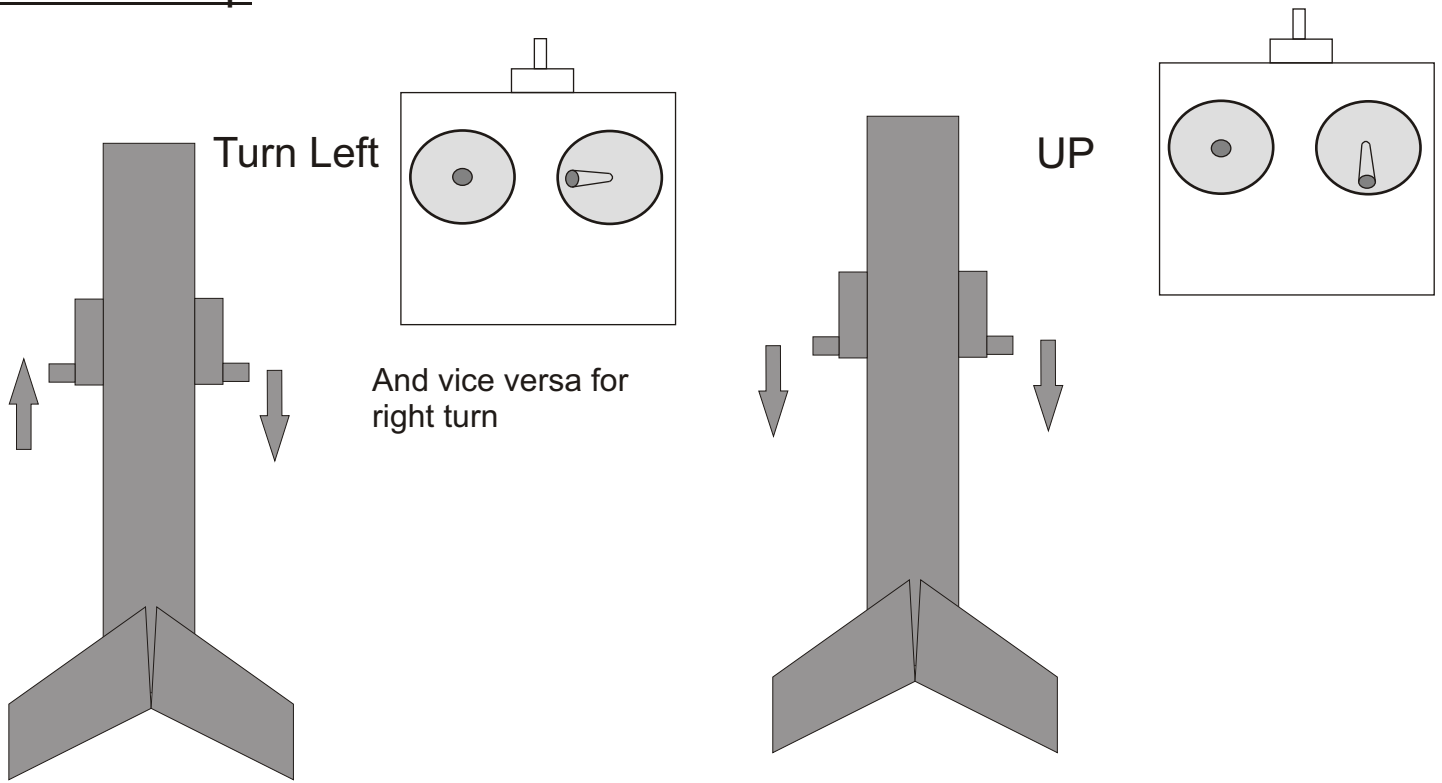

You will require a transmitter capable of V-Tail mixing, elevon or delta mixing also works. Your manual will tell you whether your transmitter has this function. If it does not, a small mixing module can be supplied.

Neutral position of elevator

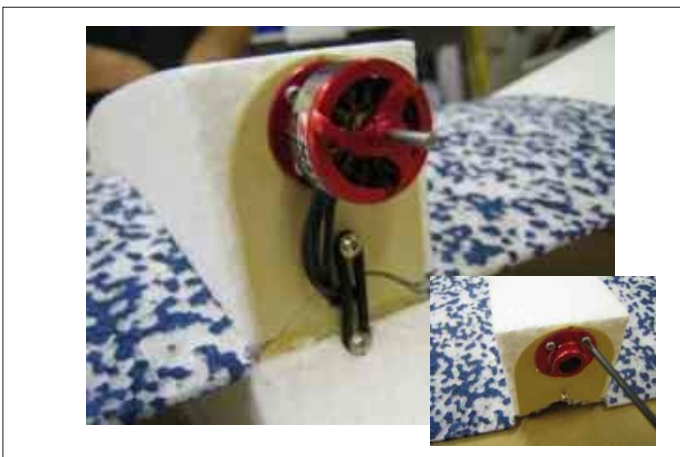
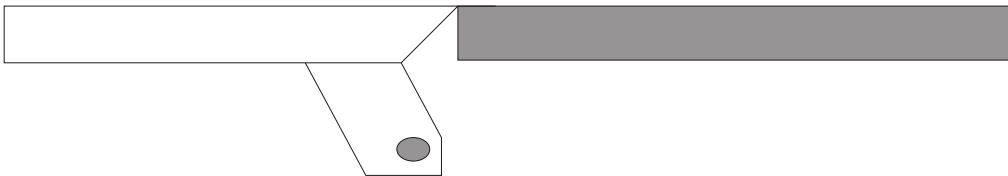

Step 27: Remove the motor back plate, screw it onto the motor plate, then re-attach the motor. See wiring diagram for motor wire connection.



Step 28: Cut a small slot in one of the fins, push the end of the aerial into it. Route the aerial along the fuselage away from the prop.

SPEED CONTROLLER TO MOTOR WIRING (FOR PUSHER).

If you wish to change the direction of the motor, swap the two outer cable around.

The speed controller requires no programming to work with 2 or 3 cell Lipo batteries (2cell for VTrainer).

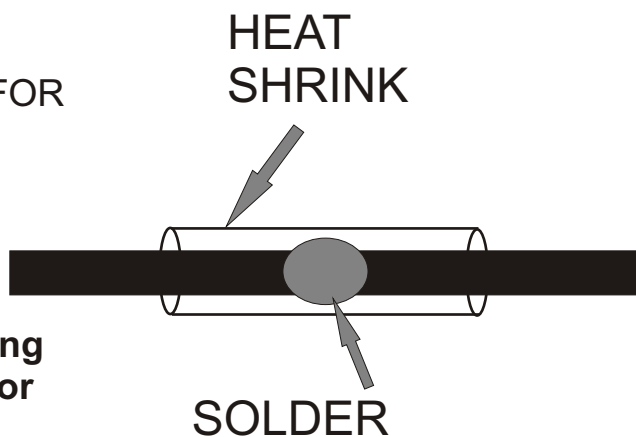

Motor with Emax 18A speed controller

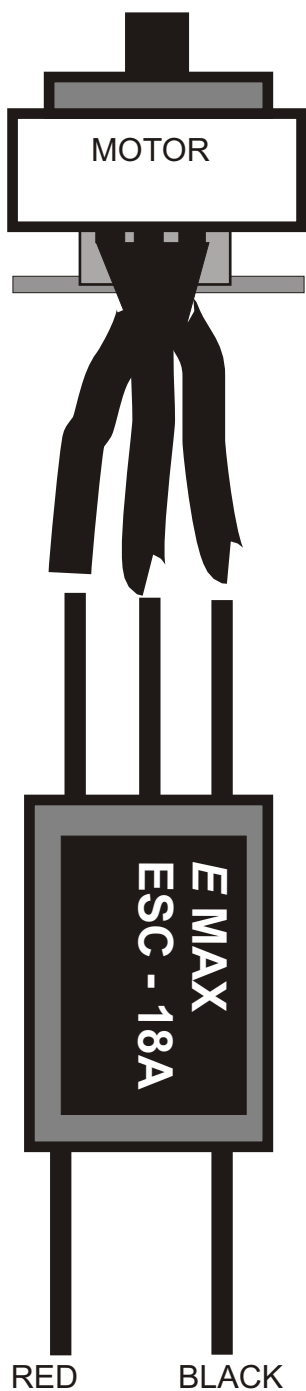

Motor with HiModel Fly 20A speed controller

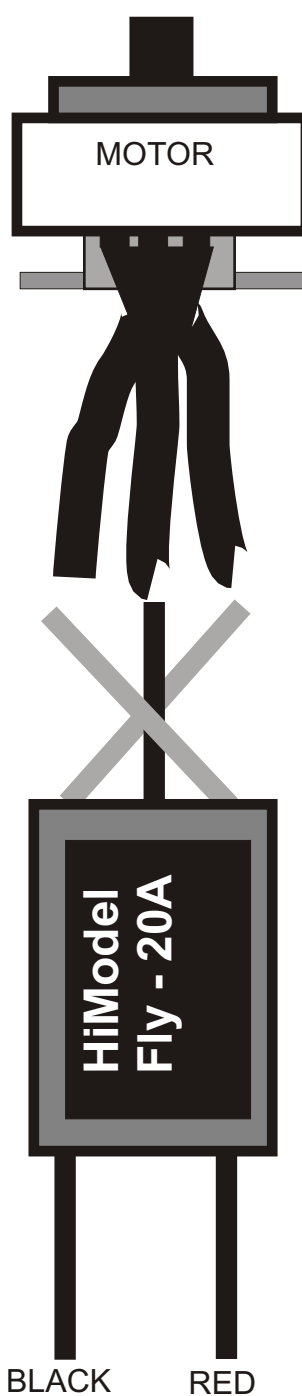

FINAL SETUP AND FLYING

Achieving the correct “centre of gravity”

Hold the model, under the wing, touching the carbon spar embedded in the wing. This is where the model should balance. It is very important to achieve the correct balance.

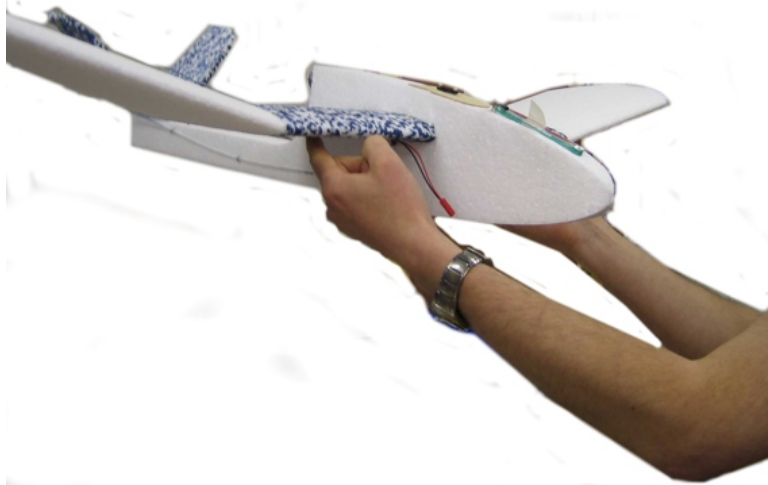

There is a small compartment under the nose of the V-Trainer for lead ballast. Add ballast to the nose and retain with some tape until balance is achieved, around 50 grams is usually enough, but this depends on the size of Lipo cell used.

When you are satisfied that the balance is correct use the spare piece of EPP block to create a plug for the ballast box and glue in place.

Flying

Double check all the controls.

1. The v-tail is operating as it should and that the neutral position is set.
2. The servos, pushrods and horns are firmly attached or screwed in.
3. The propeller is on correctly (normally writing facing forward)

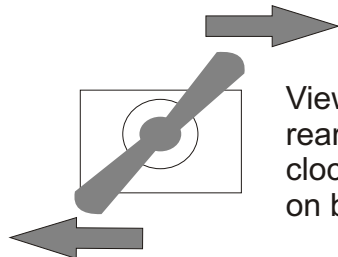

Viewing the model from the rear, the motor should run clockwise with propeller put on backwards.

4. Motor rotation is clockwise when viewed from the rear.
5. “Centre of gravity” is correct.

The V-trainer is best hand launched directly into wind, you may want to try a few hand launches without power to adjust to the model, it glides quite far without power.

Slowly build up to powered launches.

Help Line 01908 615163

Email: sales@flyingwings.co.uk

Check WWW.FLYINGWINGS.CO.UK

For more great aircraft and accessories

Spares Available:

- > Complete wing with spar
- > Complete Fuselage with tail & Spar
- > Wing & Motor plates
- > CF2805 Motor
- > 18 Amp ESC
- > 1700-2200mah Lipo Flight Packs
- > V-Tail Mixer
- > Propellers